

Harley kickstand switch
PN: E1092-B9113-24V

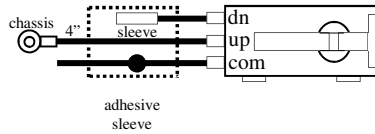

This document shall be considered PVP Communications, Inc. proprietary information and not be disclosed to any third party without the prior written consent of PVP Communications, Inc.

Date	Authorized	Description	Rev
06/21/2007	MD	Release	NC

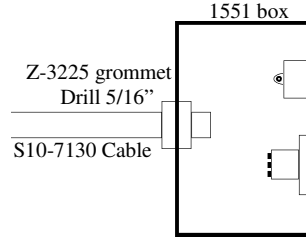
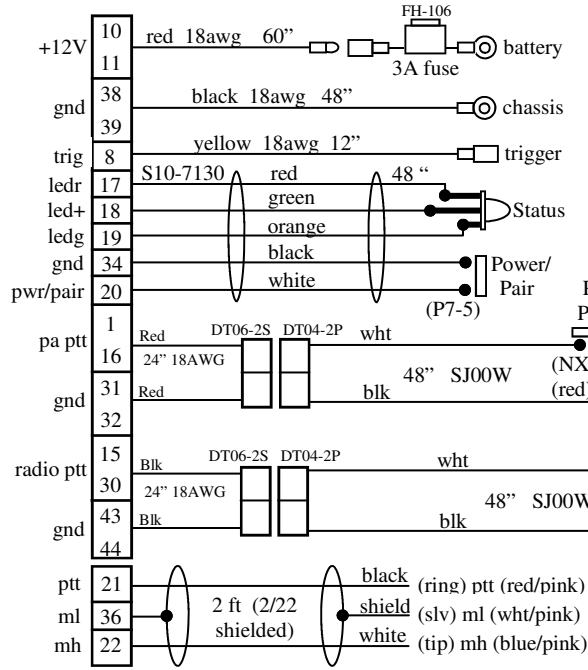

(See drawing PVMOD110-01 for Box Drilling)

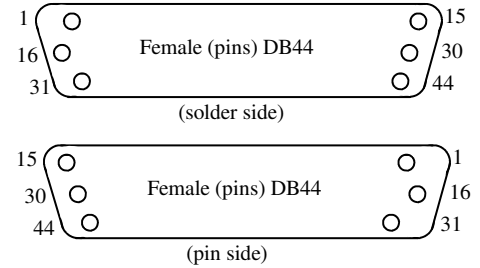

NOTES:

- 1) Install Status LED and Power/Pairing Switch in 1551 box as shown. Assemble N5040R-blk cover to P7-5 switch with star washer and 10179B boot, L30022 lens cap to LED, cover LED with adhesive sleeve, and install into GRM219P grommet.
- 2) Label as shown and include installation instructions
- 3) Ream DB44 (plastic) backshell with 1/2" Drill
- 4) Complete assembly includes Module PN: PVG2AS (not shown), Kickstand Switch Assembly PN: PVHDKCK-01, PTT Assy PN: PVPTT2-H02-DT and Harness Assembly PN: PV500M-HA-WW-XMH
- 5) Assemble O-ring, backshells, boots and PTT switches to dual Harley PTT bracket (not shown) PN: PVHARPTT-02
- 6) To panel mount Power/Pairing switch and Status LED on motor, open 1551 box, remove switch and LED. Drill 1/4" hole to install P7-5 switch on motor, drill 11/32" hole to install LED grommet on motor
- 7) Cover unused lead at kickstand switch with sleeve, then apply adhesive sleeve over cable connection
- 8) Include mounting HW noted in installation instructions
- 9) At Radio, program INP2 for PTT (*not Ext PTT*), and OUT1 for EXT MUTE (*active low*). Requires MA-COM KRD103133/45 Option Cable.

LABEL:

PV500M-HA-WW-XMH
Rev NC

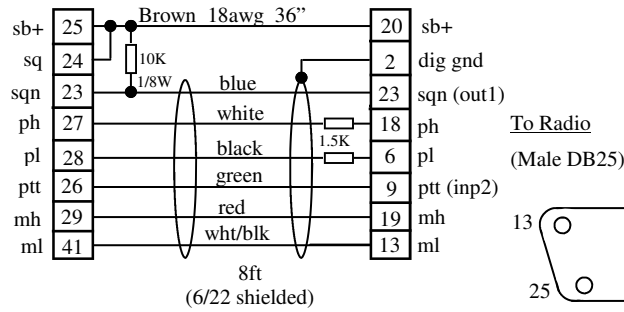

To Radio
(Male DB25)

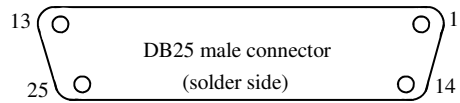

PVP Communications



Eng	Title: Motor Kit, MA-COM 500M Mobile with WS320 Siren, G2 Wireless, for Harley Motor
Check	
Date: 06/21/2007	
Sheet 1 of 1	Drawing No: PV500M-HA-WW/XM

INSTALLATION DIAGRAM

Included in this Kit:

- 1) Control Module: PVG2AS
- 2) Harness Assembly: PV500M-HA-WW-XMH
- 3) PTT Bracket: PVHARPTT-02
- 4) Kickstand Switch Assembly: PVHDKCK-01
- 5) PTT Assembly: PVPPT2-H02-DT
- 6) Tie Wraps (15)

QUESTIONS? call us at 800-584-4119 Monday through Friday, 7AM to 4PM Pacific Time, USA.

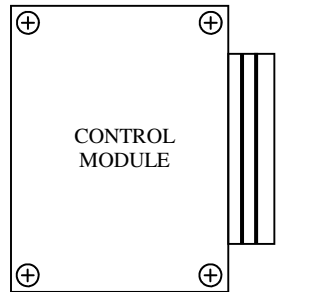

ELECTRAGLIDE - Mount MODULE directly under windshield and inside fairing
ROAD KING - Mount MODULE directly under radio control head

NOTE: Mount transceiver module away from radio speakers.

CUT OUT AND MOUNT IN CONVENIENT LOCATION:

PAIRING QUICK GUIDE

NOTE: All other Bluetooth devices in the immediate area must be powered off.

- 1) Power off both devices. Press each PAIR switch until LED goes to a solid color (2-3 seconds), then release.
- 2) Press and hold **Motor** PAIR switch until LED toggles red-green-red-green, then release it and immediately:
- 3) Press and hold **Shouldermic (or Headset)** PAIR switch until LED toggles red-green-red-green, then release.
- 4) After 10-15 seconds, a green pulse will confirm PAIR is established.

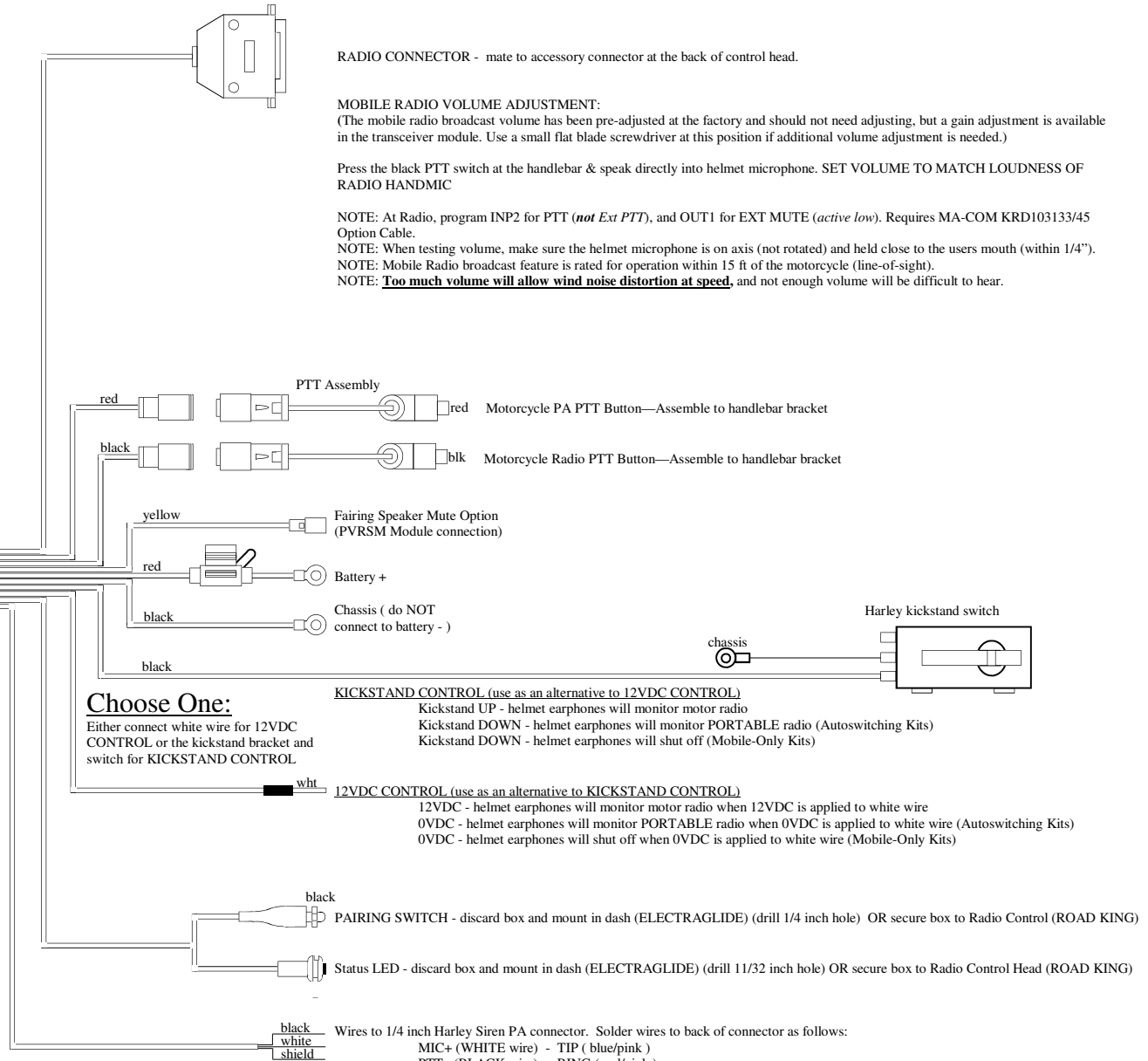

PROGRAMMING

AUTOSWITCHING SYSTEM PAIRING: The motor kit must be “paired” to a shouldermic. This creates a unique wireless link between the shouldermic and the motor kit. Once a pairing procedure has been performed, the link is “remembered” by both. A new pair may be established at any time, but until then, the shouldermic and the motor kit will remain “faithful”, responding only to their mate. They will remember who their mate is—even after having been powered off.

- A) Connect helmet to shouldermic. The shouldermic will power on and the LED will begin to flash.
NOTE: Helmet must be connected to the shouldermic to power on.
- B) Power off by pressing the power switch for 2-3 seconds until the LED transitions to a solid color, then release.
- C) Turn on the mobile radio to activate the Motor Kit (auto power-on mode) - the motor status LED will begin to flash. Manually power off the Motor Kit by pressing the power switch for 2-3 seconds until the status LED transitions to a solid color. The release.
- D) From the powered off condition, press the Motor Kit power switch for 7-9 seconds until the LED begins toggling red-green-red-green, then release. The motor has powered on into pairing mode and is searching for a mate.
- E) *Immediately after releasing the switch at the motor*, press the power switch at the shouldermic (from the powered off condition) for 7-9 seconds until the LED begins toggling red-green-red-green, then release. The shouldermic has now powered on into pairing mode and searching for a mate.
- Within 15 seconds both devices will display a green status LED pulse, indicating that they have been successfully paired to each other.

MOBILE-ONLY SYSTEM PAIRING: The motor kit must be “paired” to a Headset. This creates a unique wireless link between the Headset and the motor kit. Once a pairing procedure has been performed, the link is “remembered” by both. A new pair may be established at any time, but until then, the Headset and the motor kit will remain “faithful”, responding only to their mate. They will remember who their mate is—even after having been powered off.

- A) If the Headset LED is flashing, power off the Headset by pressing the power switch for 2-3 seconds until the LED transitions to a solid color, then release.
- B) Turn on the mobile radio to activate the Motor Kit (auto power-on mode) - the motor status LED will begin to flash. Manually power off the Motor Kit by pressing the power switch for 2-3 seconds until the status LED transitions to a solid color. The release.
- C) From the powered off condition, press the Motor Kit power switch for 7-9 seconds until the LED begins toggling red-green-red-green, then release. The motor has powered on into pairing mode and is searching for a mate.
- D) *Immediately after releasing the switch at the motor*, press the power switch at the Headset (from the powered off condition) for 7-9 seconds until the LED begins toggling red-green-red-green, then release. The Headset has now powered on into pairing mode and searching for a mate.
- Within 15 seconds both devices will display a green status LED pulse, indicating that they have been successfully paired to each other.

POWER ON/OFF MODES:

NOTE: The Motor Kits are factory set for auto power-on mode where they will power on automatically whenever the radio power is turned on. It is recommended to leave the Kit in this configuration.

The Motor Kit may be configured for “auto power-on” mode or “manual power-on” mode:

“Auto power-on” mode causes the motor kit to power on automatically whenever it is provided with “switched battery” power through the radio interface cable connection to the mobile radio.

“Manual power-on” mode causes the motor kit to be powered on when the “Power” button is pressed. To perform a manual power-on, turn on the mobile radio, then press and hold the Power switch for 2-3 seconds until the Status LED lights. Release the switch.

NOTE: Reverse the 2-3 second procedure to manually power off.

Changing power-on modes

Verify the Kit is powered on. Press the power switch quickly 5 times within one second to place the kit in manual power-on mode. Press the power switch quickly 4 times within one second to place the kit in auto power-on mode.



INSTALLATION and OPERATING INSTRUCTIONS

Motor-One™ Wireless Mobile Radio Interface Kit with PA Broadcast for Police Motorcycles

United States Patents: 7,062,301 6,311,052 7,203,525

QUESTIONS? call us at 800-584-4119 Monday through Friday, 7AM to 4PM Pacific Time, USA.

AUTOSWITCHING OPERATION

HELMET DISCONNECTED

- 1) Attach shouldermic to portable radio, turn the radio on.
 - 2) Press shouldermic PTT switch to transmit.
- NOTE:** An additional PTT switch is located on the radio connector.
- 3) Receive audio will play at the shouldermic speaker.

HELMET ATTACHED and MOTORCYCLE KICKSTAND DOWN

- 1) Attach headset to shouldermic.
 - 2) The following will occur:
 - A) The shouldermic speaker will mute and portable radio will play at the helmet earphones.
 - B) The helmet microphone will now be activated when PTT switch is pressed.
 - C) The wireless transceiver will power-on (auto power-on mode) and the status LED will begin flashing.
- NOTE:** The shouldermic contains a rechargeable battery that powers the internal wireless transceiver, and should be charged each day. Charger connects at the headset connector port.
- ### **HELMET ATTACHED and MOTORCYCLE KICKSTAND UP**
- When paired (see **PAIRING** procedure), the shouldermic and motor kit status LED's will display a green pulse, allowing the following:
- 1) The black handlebar PTT switch will activate mobile radio transmit using the helmet microphone.
 - 2) The red handlebar PTT switch will activate PA broadcast using the helmet microphone.
- NOTE:** Regardless of kickstand position, any PTT switch can be used *at any time*.
- 3) The shouldermic PTT switch will activate portable radio transmit using the helmet microphone.
- NOTE:** For Motor Kits equipped with Remote Speaker Mute (PV-RSM) option, pressing the PTT switch at the Shouldermic will cause the mobile radio speaker to mute.
- 4) Helmet Earphones - With the kickstand is up, helmet earphones will play the mobile radio. With the kickstand down, helmet earphones will play the portable radio.

MOBILE-ONLY OPERATION

- 1) Turn the Wireless Headset on. The Headset status LED will begin flashing.
- NOTE:** The Headset contains a rechargeable battery that powers the internal wireless transceiver, and should be charged each day.
- 2) When paired (see **PAIRING** procedure), the Headset and Motor Kit status LED's will display a green pulse, allowing the following:
 - a) The black handlebar PTT switch will activate mobile radio transmit using the helmet microphone.
 - b) The red handlebar PTT switch will activate PA broadcast using the helmet microphone.
- NOTE:** Regardless of kickstand position, any PTT switch can be used *at any time*.
- c) Helmet Earphones - With the kickstand is up, helmet earphones will play the mobile radio. With the kickstand down, helmet earphones will be turned off.