

This document shall be considered PVP Communications, Inc. proprietary information and not be disclosed to any third party without the prior written consent of PVP Communications, Inc.			
Date	Authorized	Description	Rev
04/28/2006	MD	Release	NC
03-27-07	MD	Add 1.5K, move SB	A
04-06-07	MD	Add Mic En	B
05-27-09	MD	Add cap and resistor to PA	C

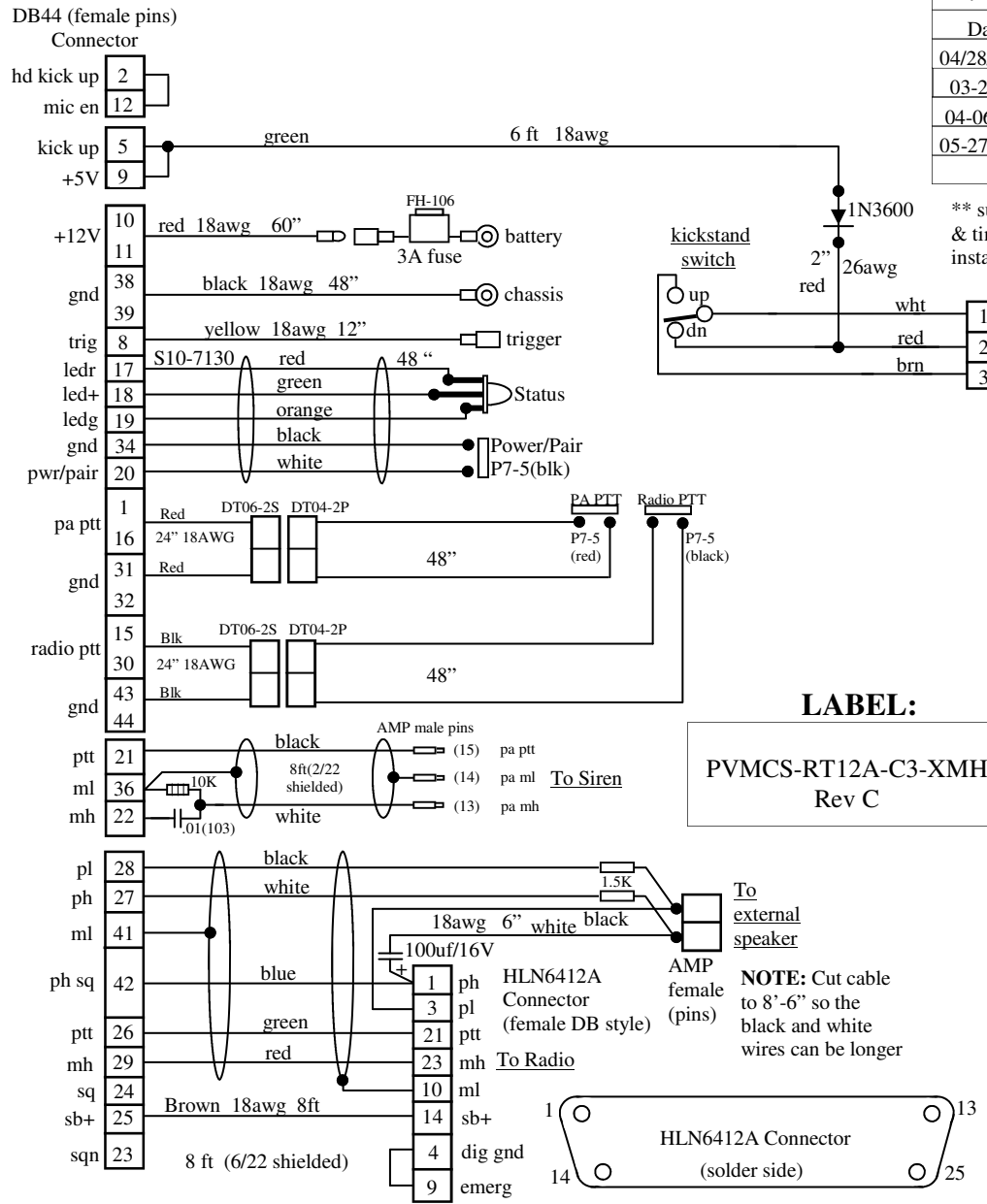

LABEL:
PVMCS-RT12A-C3-XXMH
Rev C

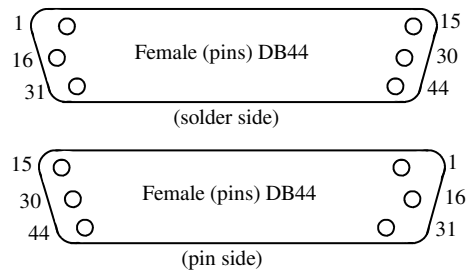

- NOTES:**
- 1) Assemble L30022 lens cap to LED, cover with adhesive sleeve, and install into GRM219P grommet
 - 2) Label as shown and include installation instructions
 - 3) Ream DB44 (plastic) backshell with 1/2" Drill
 - 4) Complete assembly includes Module (PN: PVG2AS) (not shown), and Harness Assembly PN: PVMCS-RT12A-C3-XXMH
 - 5) Use P7-5 switch with 10179B boot, and N5040R-red or N5040R-blk cover. Include star washer for each switch.
 - 6) Drill 1/4" hole to install P7-5 switches on motor, drill 11/32" hole to install LED grommet on motor
 - 7) When installing, internal speaker mode must be disabled (no jumper from pins 1 to 2 in radio connector)
 - 8) Include dual RT1200 PTT bracket (not shown) PN: PVRT12PTT-02

PVP Communications

Eng	Title: Motor Kit, MCS Mobile with CODE3 Siren, G2 Wireless, for BMW RT1200
Check	
Date: 04/28/2006	
Sheet 1 of 1	Drawing No: PVMCS-RT12A-C3/XXM

INSTALLATION DIAGRAM

Included in this Kit:

- 1) Control Module: PVG2AS
- 2) Harness Assembly: PVMCS-RT12A-C3-XMH
- 3) PTT Bracket: PVRT12PTT-02
- 4) PTT Assembly: PVPTT-B02-DT
- 5) Tie Wraps (15)

QUESTIONS? call us at 800-584-4119 Monday through Friday, 7AM to 4PM Pacific Time, USA.

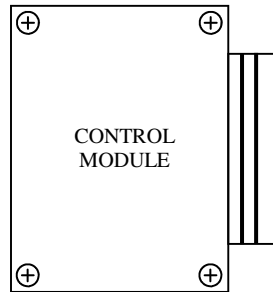

Mount MODULE directly under wind-shield and inside fairing

NOTE: Mount transceiver module away from radio speakers.

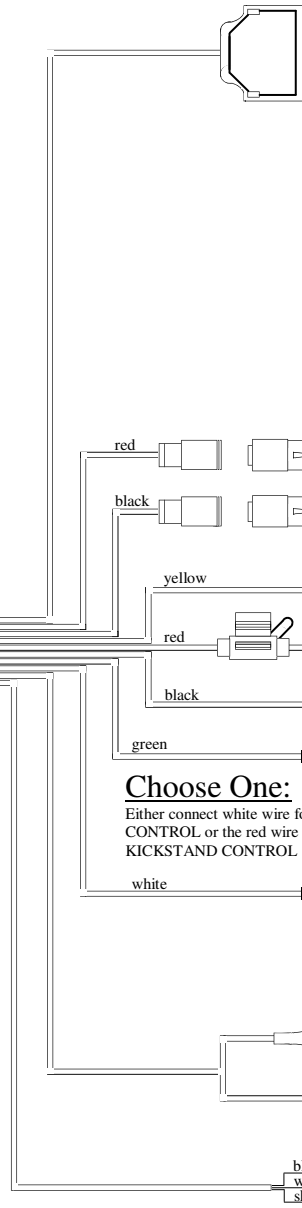
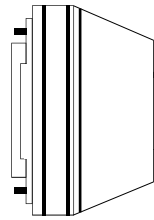

RADIO CONNECTOR - mate to accessory connector at the transceiver.

MOBILE RADIO VOLUME ADJUSTMENT:

(The mobile radio broadcast volume has been pre-adjusted at the factory and should not need adjusting, but a gain adjustment is available in the transceiver module. Use a small flat blade screwdriver at this position if additional volume adjustment is needed.)

Press the black PTT switch at the handlebar & speak directly into helmet microphone. SET VOLUME TO MATCH LOUDNESS OF RADIO HANDMIC

NOTE: Verify SB+ (pin 14) is enabled.

NOTE: When testing volume, make sure the helmet microphone is on axis (not rotated) and held close to the users mouth (within 1/4").

NOTE: Mobile Radio broadcast feature is rated for operation within 15 ft of the motorcycle (line-of-sight).

NOTE: **Too much volume will allow wind noise distortion at speed**, and not enough volume will be difficult to hear.

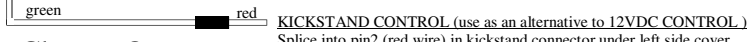
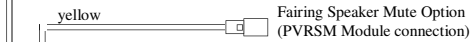
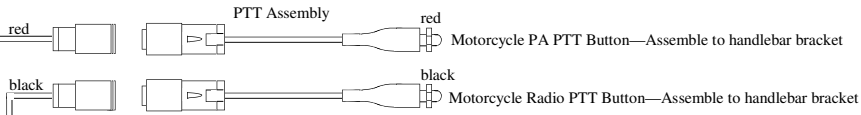

Choose One:
Either connect white wire for 12VDC CONTROL or the red wire for KICKSTAND CONTROL

KICKSTAND CONTROL (use as an alternative to 12VDC CONTROL)
Splice into pin2 (red wire) in kickstand connector under left side cover
Kickstand UP - helmet earphones will monitor motor radio
Kickstand DOWN - helmet earphones will monitor PORTABLE radio (Autoswitching Kits)
Kickstand DOWN - helmet earphones will shut off (Mobile-Only Kits)

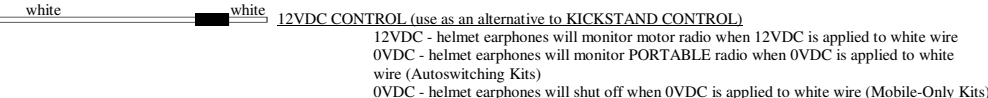

12VDC CONTROL (use as an alternative to KICKSTAND CONTROL)
12VDC - helmet earphones will monitor motor radio when 12VDC is applied to white wire
0VDC - helmet earphones will monitor PORTABLE radio when 0VDC is applied to white wire (Autoswitching Kits)
0VDC - helmet earphones will shut off when 0VDC is applied to white wire (Mobile-Only Kits)

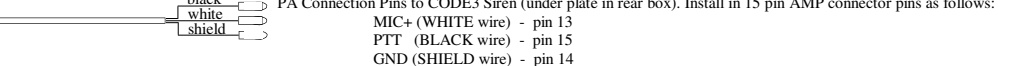
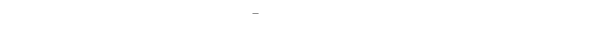

PA Connection Pins to CODE3 Siren (under plate in rear box). Install in 15 pin AMP connector pins as follows:
MIC+ (WHITE wire) - pin 13
PTT (BLACK wire) - pin 15
GND (SHIELD wire) - pin 14

PA VOLUME:
Adjust the helmet microphone PA transmit volume with a small flat screwdriver on the siren amplifier (located on the right side of the siren amplifier).
NOTE: An additional gain adjust is available in the Control Module if additional volume adjustment is needed.
NOTE: When testing PA volume, make sure the siren speaker is directed to an open area to avoid improper feedback.
NOTE: When testing PA volume, make sure the helmet microphone is on axis (not rotated) and held close to the users mouth (within 1/4").

CUT OUT AND MOUNT IN CONVENIENT LOCATION:

PAIRING QUICK GUIDE

NOTE: All other Bluetooth devices in the immediate area must be powered off.

- 1) Power off both devices. Press each PAIR switch until LED goes to a solid color (2-3 seconds), then release.
- 2) Press and hold **Motor** PAIR switch until LED toggles red-green-red-green, then release it and immediately:
- 3) Press and hold **Shouldermic (or Headset)** PAIR switch until LED toggles red-green-red-green, then release.
- 4) After 10-15 seconds, a green pulse will confirm PAIR is established.

PROGRAMMING

AUTOSWITCHING SYSTEM PAIRING: The motor kit must be “paired” to a shouldermic. This creates a unique wireless link between the shouldermic and the motor kit. Once a pairing procedure has been performed, the link is “remembered” by both. A new pair may be established at any time, but until then, the shouldermic and the motor kit will remain “faithful”, responding only to their mate. They will remember who their mate is—even after having been powered off.

- A) Connect helmet to shouldermic. The shouldermic will power on and the LED will begin to flash.
NOTE: Helmet must be connected to the shouldermic to power on.
- B) Power off by pressing the power switch for 2-3 seconds until the LED transitions to a solid color, then release.
- C) Turn on the mobile radio to activate the Motor Kit (auto power-on mode) - the motor status LED will begin to flash. Manually power off the Motor Kit by pressing the power switch for 2-3 seconds until the status LED transitions to a solid color. The release.
- D) From the powered off condition, press the Motor Kit power switch for 7-9 seconds until the LED begins toggling red-green-red-green, then release. The motor has powered on into pairing mode and is searching for a mate.
- E) *Immediately after releasing the switch at the motor*, press the power switch at the shouldermic (from the powered off condition) for 7-9 seconds until the LED begins toggling red-green-red-green, then release. The shouldermic has now powered on into pairing mode and searching for a mate.
- Within 15 seconds both devices will display a green status LED pulse, indicating that they have been successfully paired to each other.

MOBILE-ONLY SYSTEM PAIRING: The motor kit must be “paired” to a Headset. This creates a unique wireless link between the Headset and the motor kit. Once a pairing procedure has been performed, the link is “remembered” by both. A new pair may be established at any time, but until then, the Headset and the motor kit will remain “faithful”, responding only to their mate. They will remember who their mate is—even after having been powered off.

- A) If the Headset LED is flashing, power off the Headset by pressing the power switch for 2-3 seconds until the LED transitions to a solid color, then release.
- B) Turn on the mobile radio to activate the Motor Kit (auto power-on mode) - the motor status LED will begin to flash. Manually power off the Motor Kit by pressing the power switch for 2-3 seconds until the status LED transitions to a solid color. The release.
- C) From the powered off condition, press the Motor Kit power switch for 7-9 seconds until the LED begins toggling red-green-red-green, then release. The motor has powered on into pairing mode and is searching for a mate.
- D) *Immediately after releasing the switch at the motor*, press the power switch at the Headset (from the powered off condition) for 7-9 seconds until the LED begins toggling red-green-red-green, then release. The Headset has now powered on into pairing mode and searching for a mate.
- Within 15 seconds both devices will display a green status LED pulse, indicating that they have been successfully paired to each other.

POWER ON/OFF MODES:

NOTE: The Motor Kits are factory set for auto power-on mode where they will power on automatically whenever the radio power is turned on. It is recommended to leave the Kit in this configuration.

The Motor Kit may be configured for “auto power-on” mode or “manual power-on” mode:

“Auto power-on” mode causes the motor kit to power on automatically whenever it is provided with “switched battery” power through the radio interface cable connection to the mobile radio.

“Manual power-on” mode causes the motor kit to be powered on when the “Power” button is pressed. To perform a manual power-on, turn on the mobile radio, then press and hold the Power switch for 2-3 seconds until the Status LED lights. Release the switch.

NOTE: Reverse the 2-3 second procedure to manually power off.

Changing power-on modes

Verify the Kit is powered on. Press the power switch quickly 5 times within one second to place the kit in manual power-on mode. Press the power switch quickly 4 times within one second to place the kit in auto power-on mode.



INSTALLATION and OPERATING INSTRUCTIONS

Motor-One™ Wireless Mobile Radio Interface Kit with PA Broadcast for Police Motorcycles

United States Patents: 7,062,301 6,311,052 7,203,525

QUESTIONS? call us at 800-584-4119 Monday through Friday, 7AM to 4PM Pacific Time, USA.

AUTOSWITCHING OPERATION

HELMET DISCONNECTED

- 1) Attach shouldermic to portable radio, turn the radio on.
 - 2) Press shouldermic PTT switch to transmit.
- NOTE:** An additional PTT switch is located on the radio connector.
- 3) Receive audio will play at the shouldermic speaker.

HELMET ATTACHED and MOTORCYCLE KICKSTAND DOWN

- 1) Attach headset to shouldermic.
 - 2) The following will occur:
 - A) The shouldermic speaker will mute and portable radio will play at the helmet earphones.
 - B) The helmet microphone will now be activated when PTT switch is pressed.
 - C) The wireless transceiver will power-on (auto power-on mode) and the status LED will begin flashing.
- NOTE:** The shouldermic contains a rechargeable battery that powers the internal wireless transceiver, and should be charged each day. Charger connects at the headset connector port.
- ### **HELMET ATTACHED and MOTORCYCLE KICKSTAND UP**
- When paired (see **PAIRING** procedure), the shouldermic and motor kit status LED's will display a green pulse, allowing the following:
- 1) The black handlebar PTT switch will activate mobile radio transmit using the helmet microphone.
 - 2) The red handlebar PTT switch will activate PA broadcast using the helmet microphone.
- NOTE:** Regardless of kickstand position, any PTT switch can be used *at any time*.
- 3) The shouldermic PTT switch will activate portable radio transmit using the helmet microphone.
- NOTE:** For Motor Kits equipped with Remote Speaker Mute (PV-RSM) option, pressing the PTT switch at the Shouldermic will cause the mobile radio speaker to mute.
- 4) Helmet Earphones - With the kickstand is up, helmet earphones will play the mobile radio. With the kickstand down, helmet earphones will play the portable radio.

MOBILE-ONLY OPERATION

- 1) Turn the Wireless Headset on. The Headset status LED will begin flashing.
- NOTE:** The Headset contains a rechargeable battery that powers the internal wireless transceiver, and should be charged each day.
- 2) When paired (see **PAIRING** procedure), the Headset and Motor Kit status LED's will display a green pulse, allowing the following:
 - a) The black handlebar PTT switch will activate mobile radio transmit using the helmet microphone.
 - b) The red handlebar PTT switch will activate PA broadcast using the helmet microphone.
- NOTE:** Regardless of kickstand position, any PTT switch can be used *at any time*.
- c) Helmet Earphones - With the kickstand is up, helmet earphones will play the mobile radio. With the kickstand down, helmet earphones will be turned off.